

PANCA

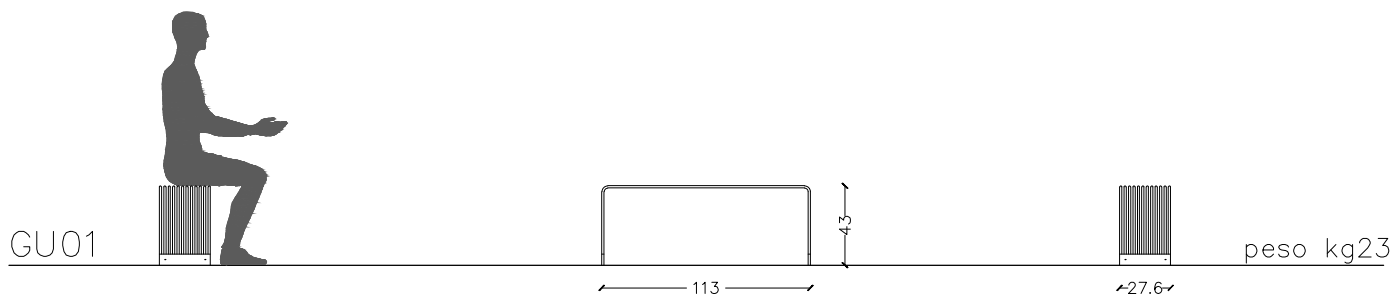

U01V slitta per terreno vegetale peso kg 19

U01S staffa per pavimentazione solida

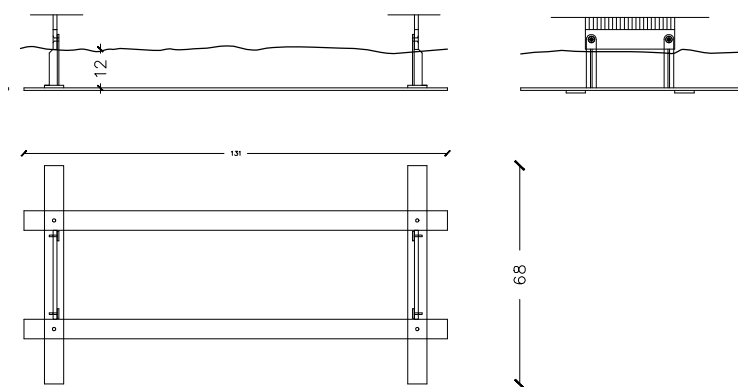

spessori per livellamento

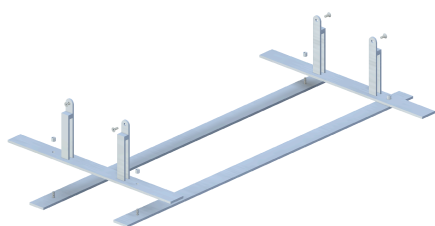
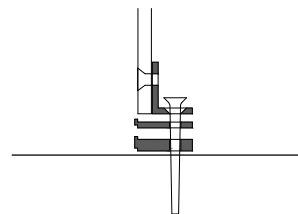

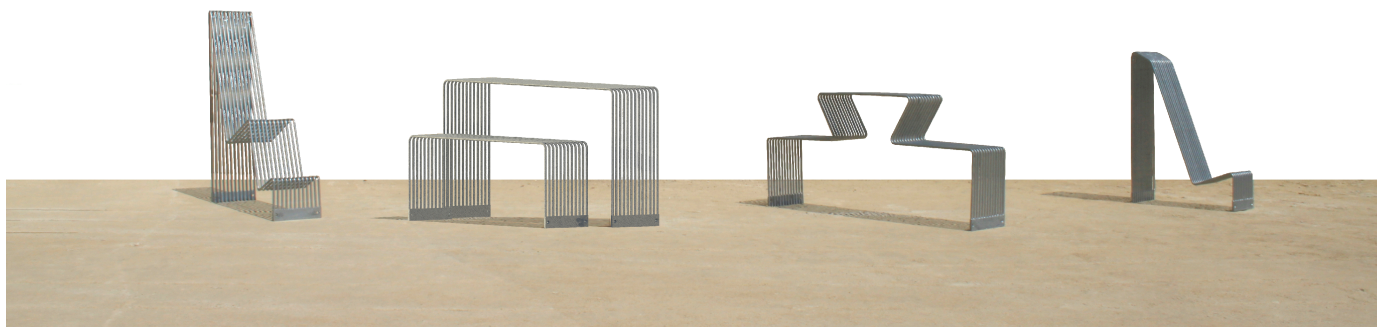

TAVOLO

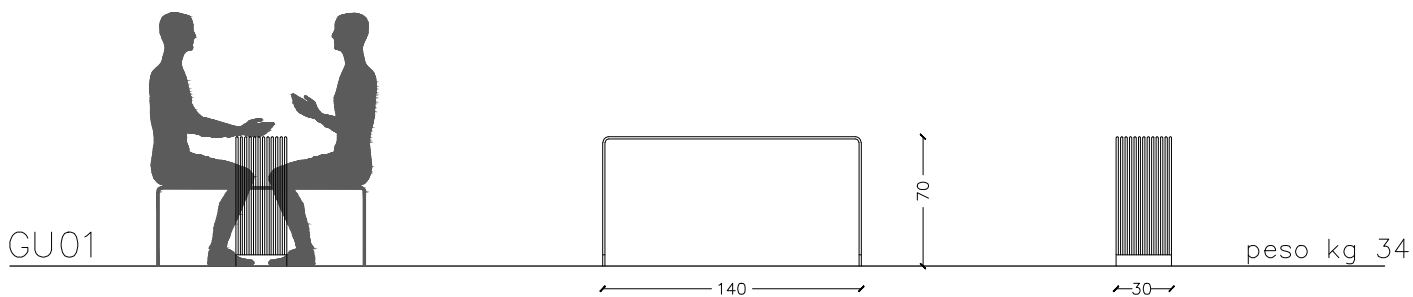

U04V slitta per terreno vegetale peso kg 19

GU01S staffa per pavimentazione solida

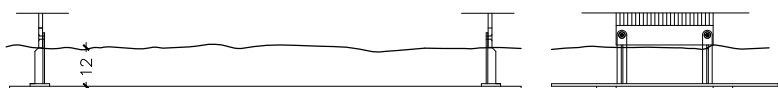

spessori per livellamento

